

**HIWIN<sup>®</sup>**

Motion Control & Systems



## Linear Actuators



## Linear Actuators

### Linear Actuators

HIWIN linear actuators are not only employed in the fields of rehabilitation and home care but also in industrial technology. They are characterized by a light and compact design, high rigidity, user-friendly handling, easy installation and low operating noise.

An inserted gear convey the rotary motion of the engine to a buttress or a ballscrew. This one converts the rotary motion into linear motion. In addition to our standard versions HIWIN linear actuators can also be designed according to the individual wishes of our customers.

# Linear Actuators

Contents

---

## Contents

1	Product overview.....	7
2	General information.....	8
2.1	Selection of HIWIN linear actuators	8
2.2	Installation of the HIWIN linear actuators	8
2.3	Safe operation of HIWIN linear actuators	8
2.4	Features and applications	9
3	HIWIN linear actuators LAS.....	10
3.1	LAS1	10
3.2	LAS3	12
4	HIWIN linear actuators LAN.....	14
4.1	LAN5	14
5	Customer specific linear actuators.....	16

# Linear Actuators

Product overview

---

## 1. Product overview



HIWIN linear actuator LAS1

[Page 10](#)

- Standard cylinder
- Thrust from 600 to 1,200 N
- IP54

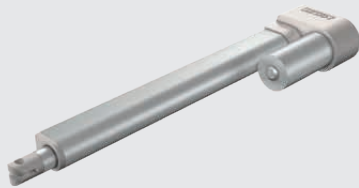

HIWIN linear actuator LAS3

[Page 12](#)

- Standard cylinder with distance measuring system
- Thrust from 600 to 1,200 N
- IP54

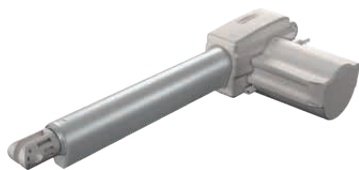

HIWIN linear actuator LAN5

[Page 14](#)

- Heavy load cylinder
- Thrust from 3,000 to 8,000 N
- IP66

Customer specific linear actuators

[Page 16](#)

- Customised versions
- Wide range of options

# Linear Actuators

## General information

---

### 2. General information

#### 2.1 Selection of HIWIN linear actuators

##### Step 1: Calculating load and speed

The model selected from the various HIWIN linear actuators depends on the operating environment, the load levels, and the required speed.

##### Step 2: Required stroke and zero stroke length

The required stroke depends on the application. The zero stroke length ( $R_0$ ) is the minimum length of a linear actuator with fully retracted piston rod. Accordingly, the maximum length with fully extended piston rod is the zero stroke length plus the selected stroke.

##### Step 3: Effects on the duty cycle

Linear actuators are designed for a maximum duty cycle of 10 %. A longer duty cycle leads to excessive wear. Bending and impact loads must be avoided.

#### 2.2 Installation of the HIWIN linear actuators

- Linear actuators are delivered with their piston rod fully retracted (0 stroke). If this should prevent installation, the linear actuator may be powered to the required stroke position. If an auxiliary voltage is applied for this purpose, make sure that linear actuators without internal limit switches are protected against surge currents on reaching their end position.
- The linear actuators must be secured with bolts whose axes are parallel to each other. The linear actuator must be able to swivel about its mounting bolts. The mounting bolts must prevent twisting about the linear actuators' longitudinal axis, i.e. they must function as an antitwist lock.
- Linear actuators are not suitable for absorbing bending moments or lateral forces.
- The linear actuators' swivelling motions must be taken into account when the power lines are routed.
- Linear actuators without integrated limit switches must be connected to external limit switches or excess current monitors that switch OFF the power.
- Check that the linear actuator functions properly after installation.

##### Users should consider the following:

- The stroke selected for the linear actuator must be adequate for the application.
- The limit switches must be actuated reliably at the end of the stroke.
- At their end positions, linear actuators without integrated limit switches draw excess current that can soon damage the motors.

#### 2.3 Safe operation of HIWIN linear actuators

- The structure the linear actuators are intended to move must also serve as their guide. Unguided loads may generate bending moments that exceed the design specifications of linear actuators.
- The linear actuator's enclosing structure may not project into its area of movement.
- The voltage supplied across the linear actuator must agree with its specifications. The electric power must be adequate for the linear actuator at its peak load.
- The current draw rises rapidly when the linear actuator is overloaded or blocked. This will damage the motor. A fuse or current limiter must be provided if excess current is not to damage the linear actuator. The current monitor must safeguard the linear actuator's automatic deactivation in the event of a malfunction.
- The maximum duty cycle of HIWIN linear actuators is 10 %. There may be two minutes of full load operation within a twenty minute period. If longer duty cycles are required, a temperature monitor must be provided. If necessary, there must be forced cooling.
- If not fitted with their own, linear actuators must be protected with suitable limit switches. Limit switches restricting the stroke can be fitted separately to the moving structure or the linear actuator.



- Linear actuators without integrated limit switches or overload protection may be operated only within the specified nominal stroke.
- Linear actuators are powered from a DC supply. The DC motor's polarity must be reversed for reversed movements. Additional braking effects can be obtained when a suitable switch is fitted to short circuit the motor. This braking effect is not generated when the equipment is stationary.
- The linear actuators must be operated within the specified load limits. Linear actuators have been approved for a range of IP codes. Make sure that the IP code corresponds to the ambient conditions.
- Depending on the linear actuator type, the piston rod may require an antitwist lock. If not locked against twisting, the piston rod may rotate in sympathy without executing a stroke.
- Linear actuators are not suitable for applications requiring high accuracies and defined speeds.

## 2.4 Features and applications

### 2.4.1 Features of the linear actuators

- Compact and light design
- User-friendly
- Easy to assemble
- Low noise motors
- Stable structure
- Optimal value for money

### 2.4.2 Applications

- Automation equipment
- Door and window drives
- Movable furniture
- Aerial tracking
- Wheel chairs
- Hospital beds
- Entertainment equipment
- Household equipment
- Adjustable office furniture
- Home care furniture and appliances
- Patient lift
- Treatment tables
- Visitor flow control
- Ventilation flaps
- Sun protection
- Rehabilitation equipment
- Motor home equipment

# Linear Actuators

## HIWIN linear actuators LAS

### 3. HIWIN linear actuators LAS

#### 3.1 LAS1

**Product specifications:**

- Standard cylinder
- Screw type: ACME
- Weight (at a stroke of 200 mm): 1.04 kg
- Protection class: IP54
- Operating temperature: + 5 °C to + 40 °C

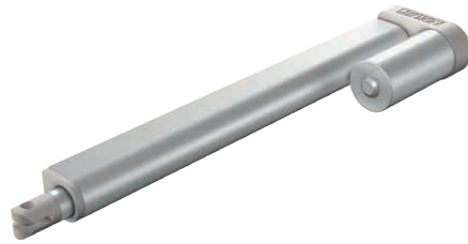

#### 3.1.1 Order code

LAS1 1 1 200 24 G E

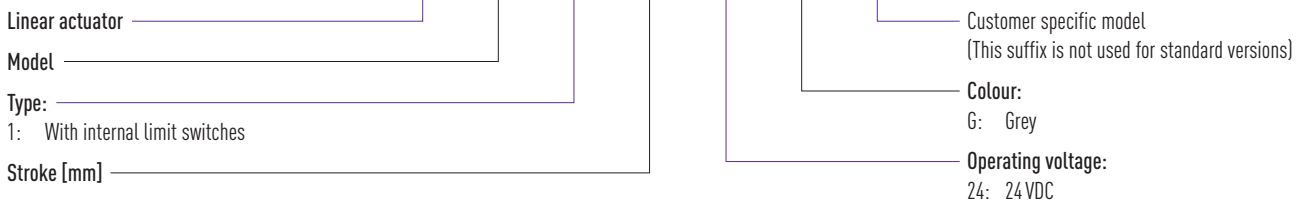

#### 3.1.2 Dimensions

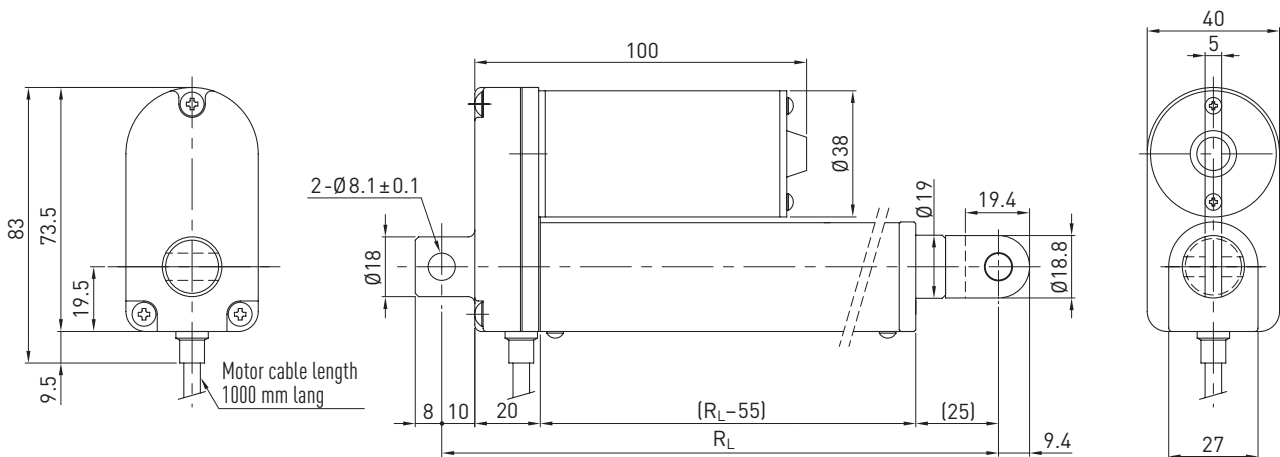

$$R_L = S + 119$$

R<sub>L</sub>: Zero stroke length [mm]

S: Stroke [mm]

**Note:**

If the mounting lugs do not lie precisely flush, the piston rod may twist as far as 180° anticlockwise.

### 3.1.3 Product characteristic curves and technical data

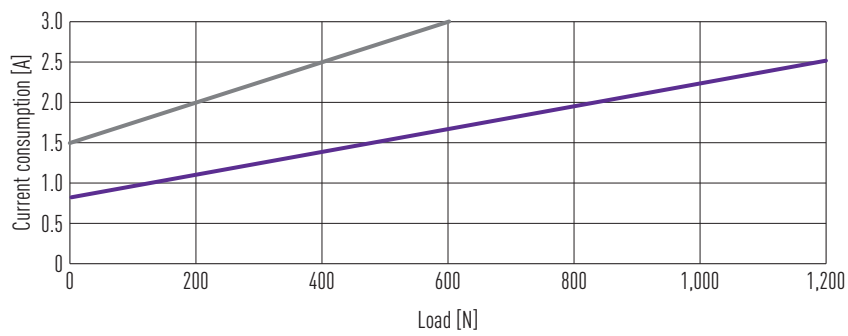
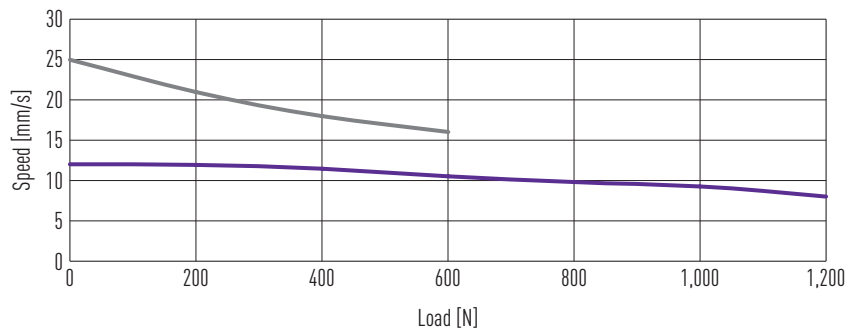

Table 3.1 **Technical data LAS1**

Model	Max. thrust [N]	Max. pull [N]	Max. holding force [N]	Speed load = max/load = 0 [mm/s]	Standard stroke S [mm]					Duty cycle [%]	Max. current (24 VDC) [A]
					50	100	150	200	250		
LAS1-1	1,200	1,200	800	8/12	50	100	150	200	250	10	2.5
LAS1-2	600	600	300	16/25	50	100	150	200	250	10	3.0

# Linear Actuators

## HIWIN linear actuators LAS

### 3.2 LAS3

#### Product specifications:

- Standard cylinder
- Distance measuring system
- Screw type: ACME
- Weight (at a stroke of 200 mm): 1.27 kg
- Protection class: IP54
- Operating temperature: +5 °C to +40 °C
- Potentiometric sensor (10 kΩ):  $R_L = S + 154$

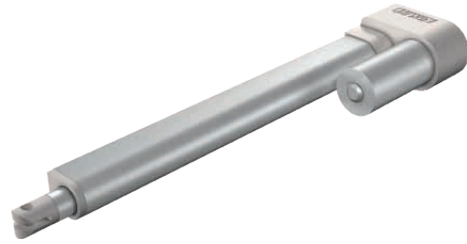

#### 3.2.1 Order code

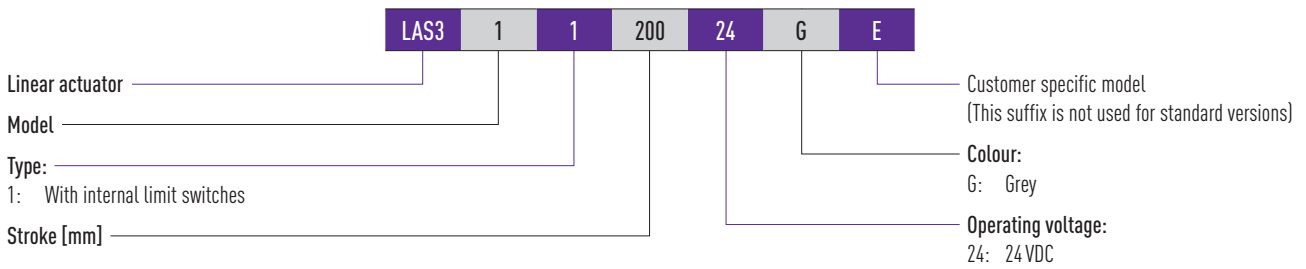

#### 3.2.2 Dimensions

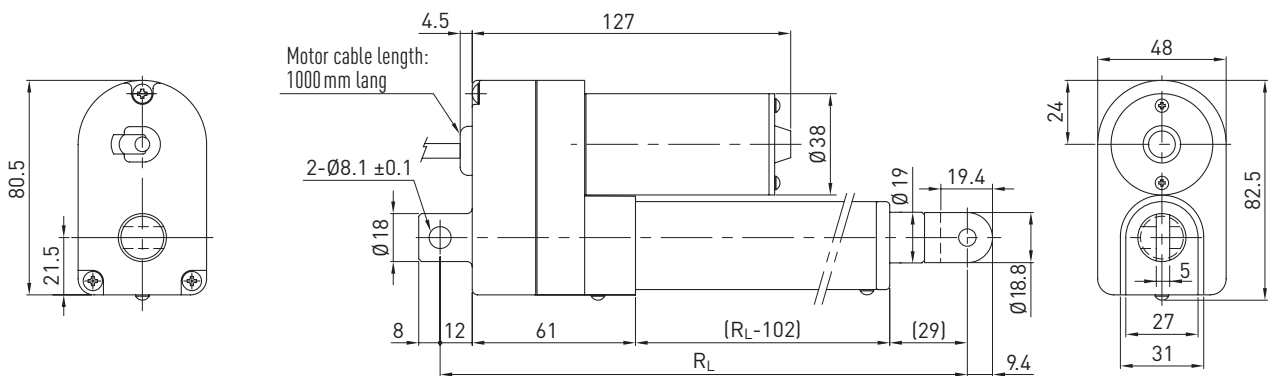

$R_L = S + 146$   
 $R_L$ : Zero stroke length  
 S: Stroke

**Note:**  
 If the mounting lugs do not lie precisely flush, the piston rod may twist as far as 180° anticlockwise.

	Supply voltage	
	24 VDC	5 VDC
Output	High level 24 VDC	TTL
	Low level 0.2 V/40 mA	—
	PNP	—
	Open collector	—

### 3.2.3 Product characteristic curves and technical data

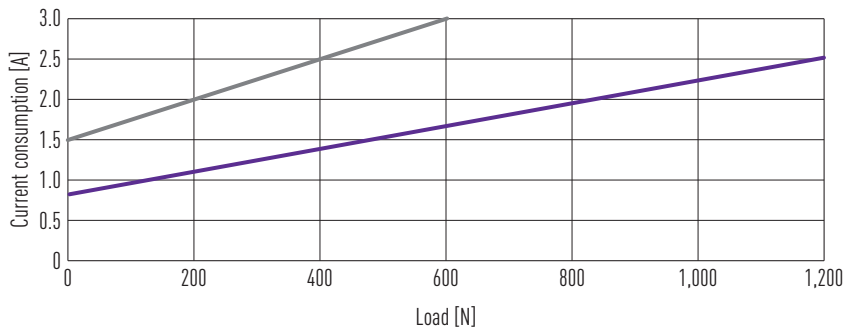
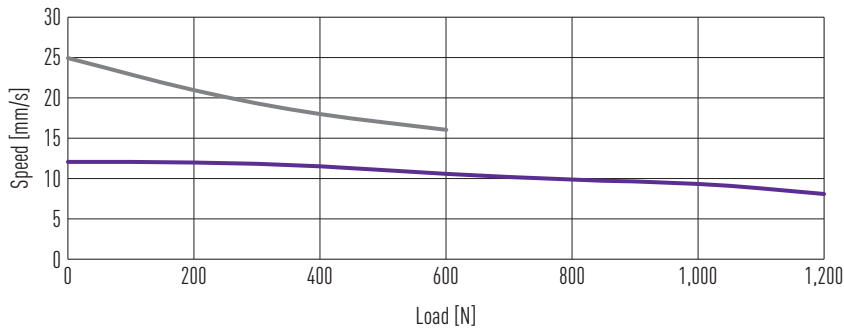

Table 3.3 Technical data LAS3

Model	Max. thrust [N]	Max. pull [N]	Max. holding force [N]	Speed load = max/load = 0 [mm/s]	Standard stroke S [mm]					Duty cycle [%]	Max. current (24 VDC) [A]	Potentiometer resolution [Ω/mm]
					50	100	150	200	250			
LAS3-1	1,200	1,200	800	8/12	50	100	150	200	250	10	2.5	21.0
LAS3-2	600	600	300	16/25	50	100	150	200	250	10	3.0	10.5

# Linear Actuators

HIWIN linear actuators LAN

## 4. HIWIN linear actuators LAN

### 4.1 LAN5

**Product specifications:**

- Heavy load cylinder
- Thrust up to 8,000 N
- Screw type: ACME
- Weight (at a stroke of 200 mm): 1.96 kg
- Protection class: IP66
- Operating temperature: +5 °C to +40 °C



#### 4.1.1 Order code

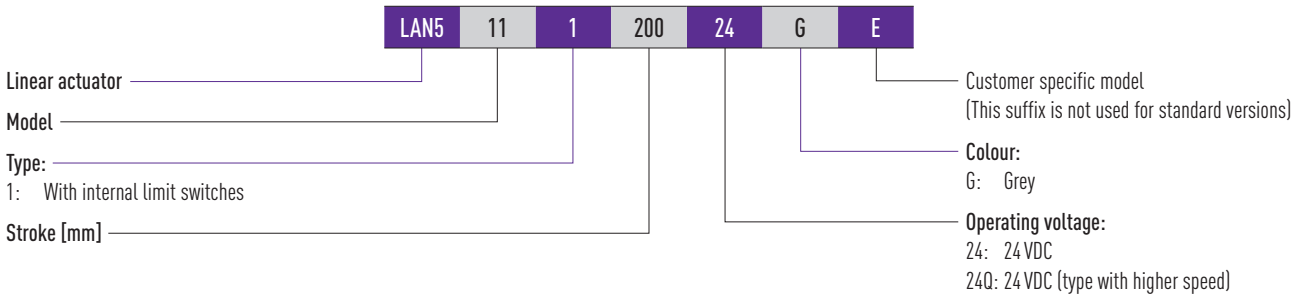

#### 4.1.2 Dimensions

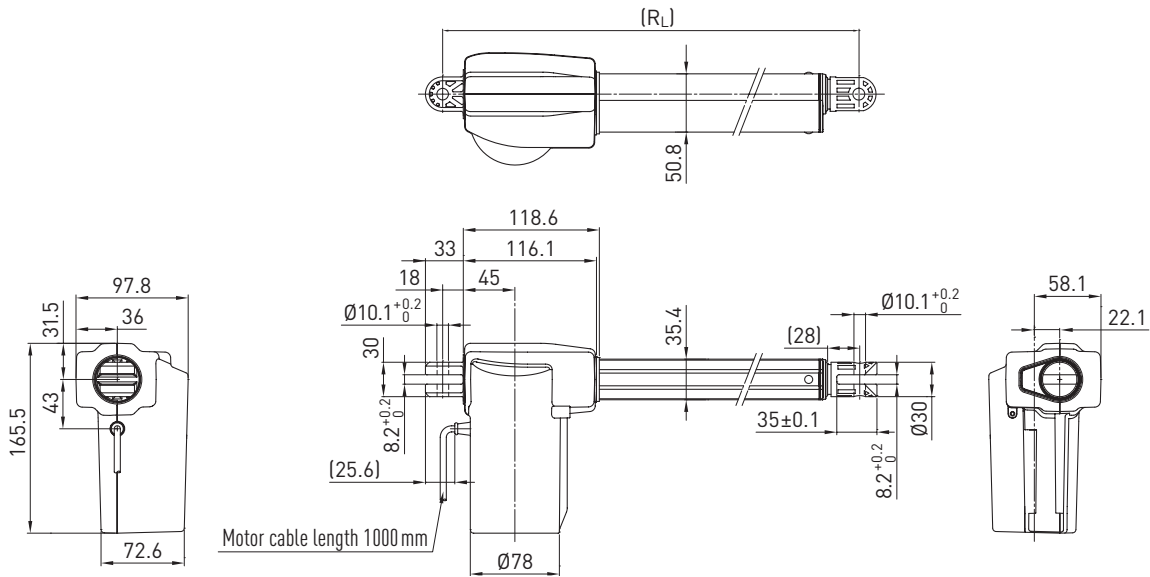

**LAN5-1:**

$R_L = S + 163$  für Hub  $\leq 200$  mm  
 $R_L = S + 213$  für Hub  $> 200$  mm

**LAN5-2/LAN5-3/LAN5-4:**

$R_L = S + 163$  für Hub  $\leq 250$  mm  
 $R_L = S + 213$  für Hub  $> 250$  mm

$R_L$ : Zero stroke length  
 S: Stroke

### 4.1.3 Product characteristic curves and technical data LAN5, 24 VDC motor and 24 VDC higher speed motor version (24Q)

24 VDC motor

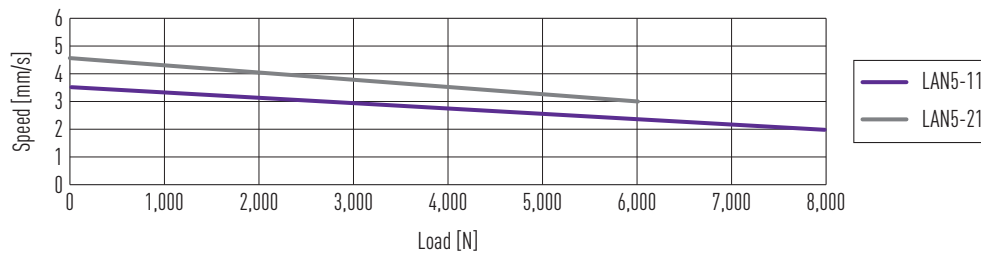

24 VDC motor (24Q)

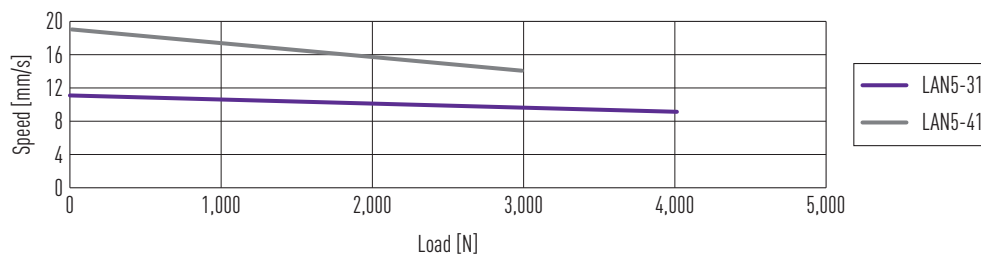

24 VDC motor

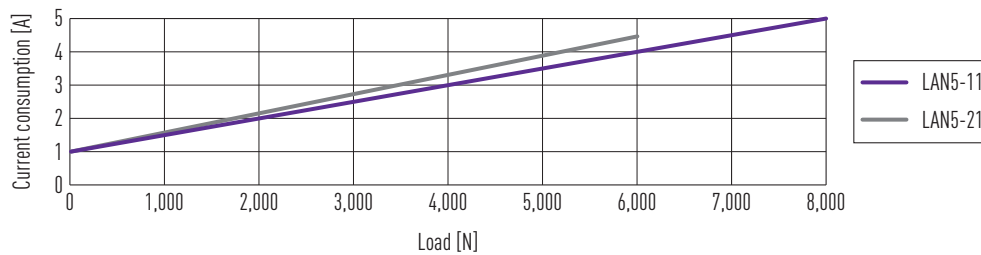

24 VDC motor (24Q)

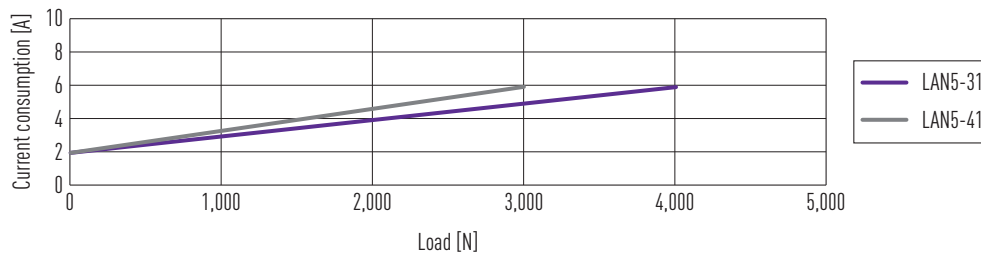

Table 4.1 Technical data LAN5, 24 VDC motor and 24 VDC higher speed motor version (24Q)

Model	Motor	Max. thrust [N]	Max. pull [N]	Max. holding force [N]	Speed load = max/load = 0 [mm/s]	Standard stroke S [mm]					Duty cycle [%]	Max. current (24 VDC) [A]	Hall sensor resolution [mm/pulse]
						100	150	200	250	300			
LAN5-11	24 VDC	8,000	4,000	6,000	2/3.5	100	150	200	—	—	10	5.0	0.08
LAN5-21	24 VDC	6,000	4,000	5,000	3/4.5	100	150	200	250	—	10	4.5	0.10
LAN5-31	24 VDC (24Q)	4,000	3,000	4,000	9/11	100	150	200	250	300	10	6.0	—
LAN5-41	24 VDC (24Q)	3,000	2,000	1,500	14/19	100	150	200	250	300	10	6.0	—

# Linear Actuators

## Customer specific linear actuators

### 5. Customer specific linear actuators

From a purchase quantity of more than 50 pieces, the following additional options are available for the linear actuators.

	LAS1	LAS3	LAN5
Operating voltage 12 VDC	●	●	
Housing colour black	●	●	●
Protection class IP65	●	●	Standard
Protection class IP66			●
External limit switches <sup>1)</sup>	●		
Incremental encoder (Hall sensor)		●	●
Absolute encoder (potentiometer) <sup>1)</sup>		Standard	
UL certified version			●
Mechanical spline <sup>1)2)</sup>			●
Safety nut <sup>1)3)</sup>			●
Mechanical quick release <sup>1)4)</sup>			●
Customer specific cable lengths	●	●	●
Customer specific motor connectors	●	●	●

<sup>1)</sup> Zero stroke length  $R_L$  may change

<sup>2)</sup> A linear actuator with mechanical spline generates thrust forces only. Under tractive forces, the piston rod slides out of the linear actuator to its stop. The mechanical spline therefore helps to prevent damage or injury from forcefully dropping structures.

<sup>3)</sup> The plastic nut of the ACME thread screw drive is supplemented by an additional brass safety nut. The safety nut prevents uncontrolled retraction or extension of the cylinder if the plastic nut is damaged.

<sup>4)</sup> The connection between motor and spindle can be mechanically decoupled manually. Thus, if required, the cylinder can also be retracted manually without being energized.









# We live motion.

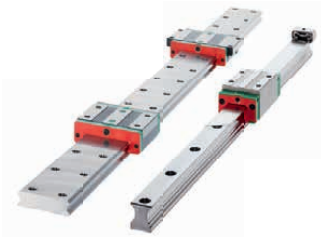

Linear Guideways



Ballscrews

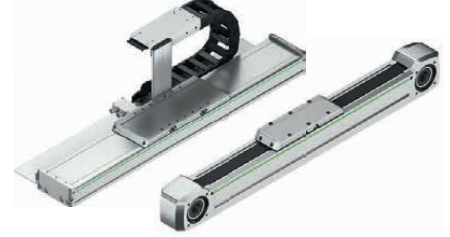

Linear Axes



Linear Axis Systems



Torque Motors



Robots



Linear Motor Components



Rotary Tables



Drives & Servo Motors

## Germany

HIWIN GmbH  
Brücklesbünd 1  
D-77654 Offenburg  
Phone +49 (0) 7 81 9 32 78 - 0  
Fax +49 (0) 7 81 9 32 78 - 90  
info@hiwin.de  
www.hiwin.de

## Taiwan

Headquarters  
HIWIN Technologies Corp.  
No. 7, Jingke Road  
Taichung Precision Machinery Park  
Taichung 40852, Taiwan  
Phone +886-4-2359-4510  
Fax +886-4-2359-4420  
business@hiwin.tw  
www.hiwin.tw

## Taiwan

Headquarters  
HIWIN Mikrosystem Corp.  
No. 6, Jingke Central Road  
Taichung Precision Machinery Park  
Taichung 40852, Taiwan  
Phone +886-4-2355-0110  
Fax +886-4-2355-0123  
business@hiwinmikro.tw  
www.hiwinmikro.tw

## France

HIWIN GmbH  
4, Impasse Joffre  
F-67202 Wolfisheim  
Phone +33 (0) 3 88 28 84 80  
info@hiwin.fr  
www.hiwin.fr

## Italy

HIWIN Srl  
Via Pitagora 4  
I-20861 Brugherio (MB)  
Phone +39 039 287 61 68  
Fax +39 039 287 43 73  
info@hiwin.it  
www.hiwin.it

## Poland

HIWIN GmbH  
ul. Putawska 405a  
PL-02-801 Warszawa  
Phone +48 22 544 07 07  
Fax +48 22 544 07 08  
info@hiwin.pl  
www.hiwin.pl

## Switzerland

HIWIN Schweiz GmbH  
Eichwiesstrasse 20  
CH-8645 Jona  
Phone +41 (0) 55 225 00 25  
Fax +41 (0) 55 225 00 20  
info@hiwin.ch  
www.hiwin.ch

## Slovakia

HIWIN s.r.o., o.z.z.o.  
Mládežnícka 2101  
SK-01701 Považská Bystrica  
Phone +421 424 43 47 77  
Fax +421 424 26 23 06  
info@hiwin.sk  
www.hiwin.sk

## Czech Republic

HIWIN s.r.o.  
Medkova 888/11  
CZ-62700 Brno  
Phone +42 05 48 528 238  
Fax +42 05 48 220 223  
info@hiwin.cz  
www.hiwin.cz

## Austria

HIWIN GmbH  
info@hiwin.at  
www.hiwin.at

## Netherlands

HIWIN GmbH  
info@hiwin.nl  
www.hiwin.nl

## Romania

HIWIN GmbH  
info@hiwin.ro  
www.hiwin.ro

## Slovenia

HIWIN GmbH  
info@hiwin.si  
www.hiwin.si

## Hungary

HIWIN GmbH  
info@hiwin.hu  
www.hiwin.hu

## China

HIWIN Corp.  
www.hiwin.cn

## Japan

HIWIN Corp.  
mail@hiwin.co.jp  
www.hiwin.co.jp

## USA

HIWIN Corp.  
info@hiwin.com  
www.hiwin.com

## Korea

HIWIN Corp.  
www.hiwin.kr

## Singapore

HIWIN Corp.  
www.hiwin.sg